

ASSA ABLOY, the global leader
in door opening solutions

Uniclass
L 4189 : N3 72
CI/SfB
(31.59) X (P2)



PEMKO

ASSA ABLOY

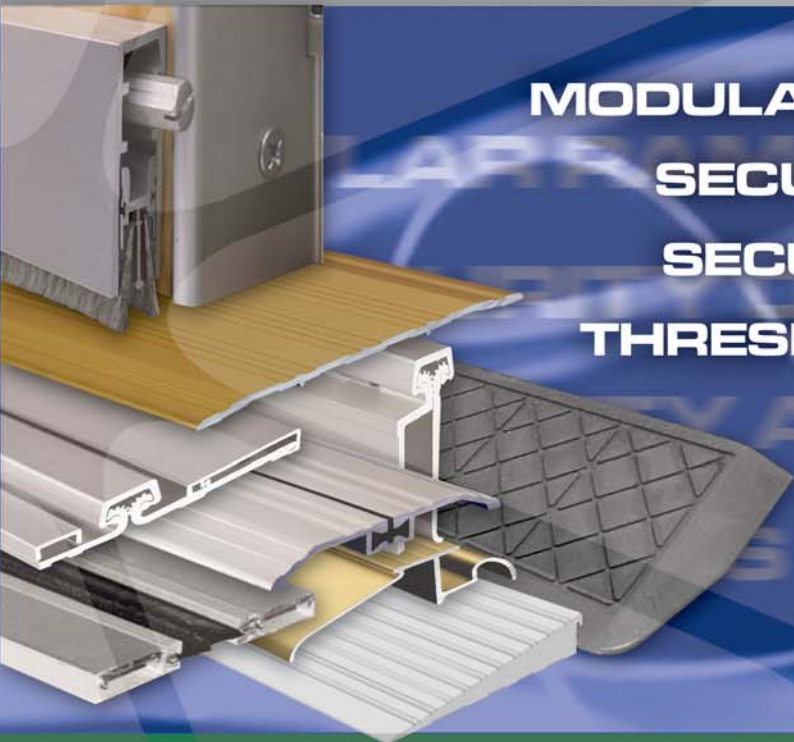

MODULAR RAMP SYSTEMS ●

SECURITY DROP SEALS ●

SECURITY ASTRAGALS ●

THRESHOLDS & SADDLES ●

HINGES ●

Technical Bulletin

ACCESS & SECURITY



*Specifically designed and
manufactured for the United Kingdom*



Welcome to



ASSA ABLOY



Since 1952, when its first plant was opened in Emeryville, California, Pemko has supplied world markets with door and threshold sealing products. Today, a worldwide distribution network is serviced by 300 employees operating from five plants in the United States and Canada.

Pemko door and threshold seals have been available in the UK for the past 15 years. Their increasing popularity with a growing range of specifiers has prompted the company to actively develop its name and product range in this country.

PEMKO IN THE UK

Literature has been produced for the UK as a series of individual leaflets, each concentrating on the specific performance requirements of acoustics, energy conservation and weatherability, access and security.

UK Building Regulations, through their Approved Documents, demand performance requirements similar to the USA from doorsets, ironmongery and seals. Consequently, Pemko products, with their innovative and attractive design features, provide a range of door and threshold seals that meet or surpass the requirements and objectives of specifiers and end user customers.

WHY CHOOSE PEMKO PRODUCTS?

Subtle differences in the design of apparently similar and competitive products can make a considerable difference to performance, maintenance and durability. Take for example, the range of Pemko automatic door bottom seals; a patented design feature ensures that through the closing action of the door, the seal drops at the hinge side first, thus reducing drag along the threshold.

Additionally, our automatic door bottom seals incorporate our own uniquely designed low closing force springs; an essential plus factor when considering the issue of access, especially for the young or people with a mobility problem.



A third example of our innovative approach to product development can be seen in the range of Pemko continuous geared aluminium hinges. Unique and maintenance free gearing means minimum effort to open or close doors of up to 345 kg. These hinges are now independently tested and approved for fire resistance, in addition to security and standard doorsets.

This dedication to product innovation extends over the whole range of Pemko door and threshold seals; even perimeter door edge seals can now be fitted with adjustable seal elements.

In meeting our customers' requirements, design and development policy is influenced by the products' ease of fitting, competitive edge and longevity. They remain eminently suitable for meeting objectives of performance from specifiers and end users in the United Kingdom, whether the application is related to industrial, residential or commercial markets.

- As part of our commitment to excellence, Pemko operates under the quality procedures of ISO 9000, meeting or exceeding independent standards of conformity, with test evidence covering issues of air infiltration, sound, access, skid resistance, fire, smoke and general weatherability.

AVAILABILITY OF PEMKO PRODUCTS

- In the UK, product distribution is provided by specialist door, hardware and seals companies who have been associated with Pemko from five to fifteen years. Our aim is to provide a choice of solutions to any problem, in a range of finishes at competitive prices.

ACCESS

The term 'Access' generally means the ease with which users can enter and circulate around a building, with due regard to other performance requirements e.g. security, fire protection etc.

In particular, access should be provided for both ambulant and wheelchair disabled persons.

To meet the needs of disabled persons, Designers should refer to BS 8300 : 2001 'Design of buildings and their approaches to meet the needs of disabled people - Code of Practice' and, 'Approved Document 'M':2004'.

Pemko offer a wide range of saddles, thresholds and ramps that satisfy the requirements of Document 'M'. The range of products is extensive and beyond the scope of this Bulletin. For further details visit our website www.pemko.com

Ramp options offered by Pemko include modular systems that can be assembled to suit virtually any length of ramp.

Pemko's Fire Retardant Rubber Ramp system incorporates anti-slip features to the satisfaction of the demanding Underwriters Laboratories standard for safety UL410 and meets the requirements of US standards ASTM D 2047 and Federal Specification P-F-430C.

Pemko also offer a Moldular Aluminium Ramp system with the same 1:12 gradient as the rubber system. This system is generally offered with a milled aluminium finish in standard sizes for site adjustment. However, this system is also offered as bespoke kits to suit pre planned details with Pemko's PemKote™ skid resistant surface providing for the same performance described for the Rubber Ramp system above.

NOTE: When required with the PemKote™ anti-skid finish, componenets are manufactured and finished in the United States of America to suit project dimensioned details. Additional lead time should be allowed.

The Modular ramp systems are offered with a variety of 'Wings' and mitred trims to match the appearance of the selected system.

For smaller projects Pemko offer fixed size rubber ramps providing for the 1:12 gradient, that is manufactured wholly from recycled rubber. These ramps incorporate Pemko's Diamond Waffle Pattern anti skid design that satisfy US anti skid performances described above. The rubber ramp assembly incorporates mitred returns and may be positioned without mechanical or adhesive fixing allowing for the transfer of the ramp to suit 'change of use' requirements.

Whereas some products are not specifically designed for disabled applications, design features incorporated into Pemko hinge and the Pemko drop seals result in a need for low operating forces that provide for ease of use for all users.



- A door operating force not exceeding 20N is required by reference to Document 'M'. This may not be achievable with some acoustic or fire rated / smoke sealed doors that are essentially sealed and closed by use of overhead door closers. However, the 'Feather Touch' function of the Pemko drop seals and the flexible nature of the S88 SiliconSeal™ provides Designers with low interference options to minimise operating forces.

NOTE: For optimum performance seals should be carefully positioned and set.

NOTE: Underwriters Laboratories standard for safety UL410 - US standards ASTM D 2047 and Federal Specification P-F-430C are American test and performance standards for skid resistance with no known BS or EN equivalent at the time of publication.

Document 'M' - Relationship of ramp gradient to the going of a flight.

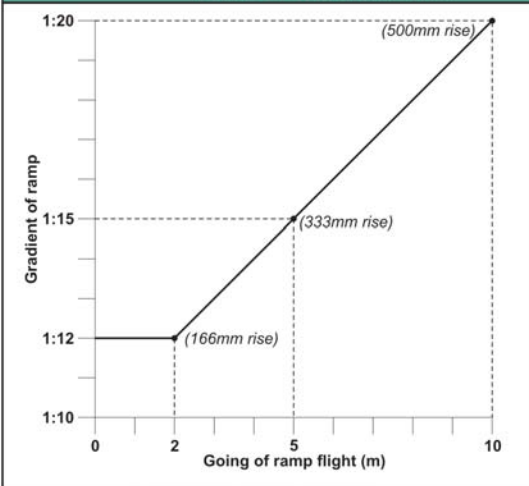

Document 'M' - Limits for Ramp Gradients

Going of a flight	Maximum gradient	Maximum rise
10m	1:20	500mm
5m	1:15	333mm
2m	1:12	166mm

NOTE: For goings between 2m and 10m, it is acceptable to interpolate between the maximum gradients, ie. 1:14 for a 4m going or 1:19 for a 9m going. (See Diagram).



PEMKO Thresholds & Saddles

Low Level Saddles/Thresholds

Pemko offer a wide range of low level thresholds for internal and external use that satisfy the requirements of Approved Documents 'M' for wheelchair disabled users of a building.

- Thresholds are offered in a range of finishes including: Mill finished Aluminium, Mill finished extruded bronze (brass), Bright-dip gold anodised aluminium, Dark bronze anodised aluminium and gold anodised aluminium.
- The Pemko 2001 low level threshold is ideally suited for external applications and incorporates the Pemko ThermoSeal™ seal for improved weather sealing, thermal insulation, acoustic and smoke sealing performances.
- For internal use the Pemko 173 Threshold strip provides for a simple low level solution where there is a change of floor finish or to improve ease of operation and the working life of doors that are fitted with drop seals or door shoes to meet smoke sealing or acoustic performance requirements.

 Visit www.pemko.com for further details.

Definitions:

Threshold: A Door related device relating to the treatment under the door leaf that may also be a Saddle.

Saddle: A device that may be independent of a door location used at the junction of floor finishes. May be used to treat junctions where floor levels vary.

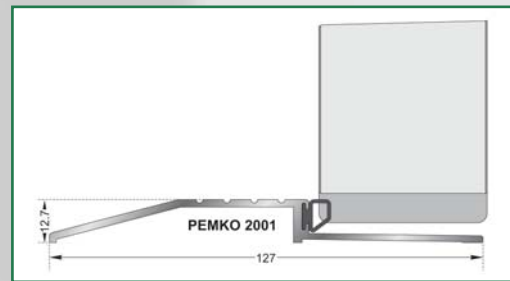
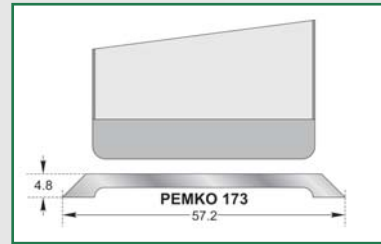

Low Level Saddles/Thresholds

- Pemko saddle thresholds are available in an extensive range of sizes.
- Saddles are offered in a range of finishes including: Mill finished Aluminium, Mill finished extruded bronze (brass), Bright-dip gold anodised aluminium, Dark bronze anodised aluminium and gold anodised aluminium.
- The 271 Saddle Threshold is one of a range of low profile saddle thresholds that meet the requirements of Approved Document 'M' and meeting the needs of the wheelchair disabled.
- Saddle Threshold designs incorporating Pemko's 'ThermoSeal™' technology for improved thermal insulation are also available without compromising the 'disabled friendly' features illustrated for the 271 saddle.

 Visit www.pemko.com for further details.

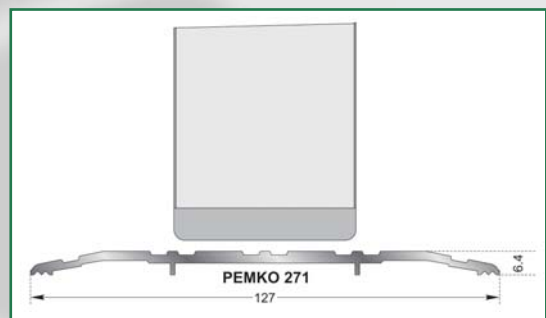

PEMKO Ramps

Fire Retardant Rubber - Modular Ramp System

- The Pemko Rubber Modular Ramp system can be assembled to meet any going length with a gradient of 1:12 to the satisfaction of Approved Document 'M' for wheelchair disabled users of a building.
- This interlocking system is treaded to provide for an 'anti-skid' performance when tested to Underwriters Laboratories UL standard for safety, UL410. The anti-skid performance meets the requirements of American Standards ASTM D 2047 and Federal Specification P-F-430C.
- The components of the modular system are extruded from styrene butadiene rubber that provides for the following performances:
 - **Long working life.**
 - **Weather and ozone resistant.**
 - **Abrasion and impact resistant.**
 - **Fire retardant.**
- The Rubber Ramp Modular System is available with Mitred Return trim fittings to provide for pleasing appearances. • The Ramp System is easy to install onto most surfaces using a construction adhesive such as 'No Nails'. If required, the Ramp system can be installed without bonding thus providing for a portable system that can be transported to suit 'change of use' requirements.



For full details, including AutoCAD downloads, visit the Pemko web site www.pemko.com.

Rubber Ramp Modular System - Primary Components

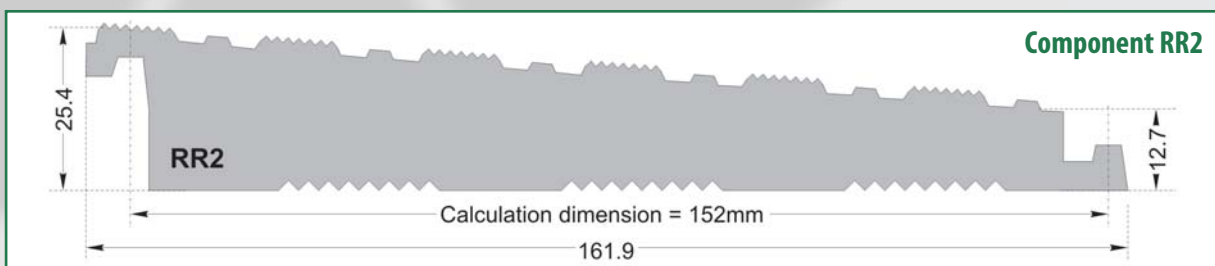
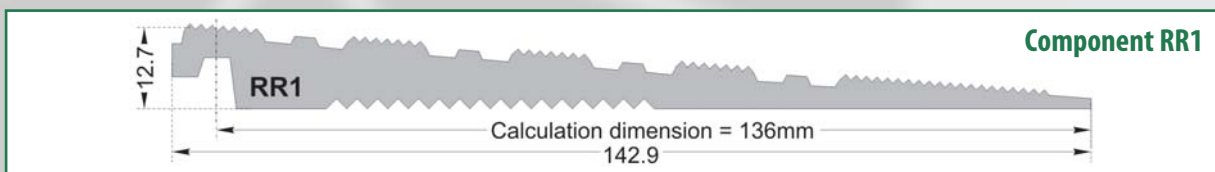

DOCUMENT 'M' - DIAGRAM SHOWING APPLICATION OF THE RUBBER MODULAR RAMP SYSTEM TO SUIT DOCUMENT 'M' MAXIMUM GOING FOR 1:12 GRADIENT'

NOTE 1: Intermediate landings to be at least 1500mm long and clear of any door swings or other obstructions.

NOTE 2: Landings at the foot and top of the ramp to be at least 1200mm long and clear of any door swings or other obstructions.

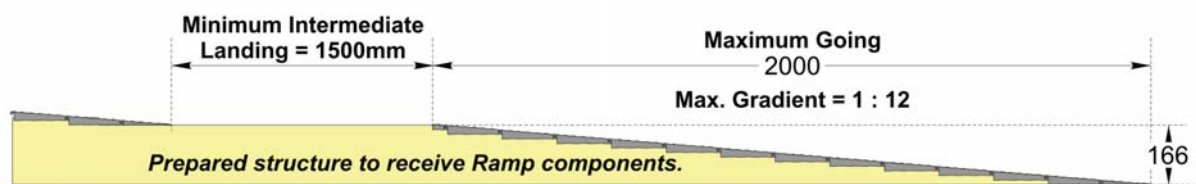

Example Calculation for maximum 2000mm going:

$2000\text{mm} - (RR1) = 136\text{mm} = 1864\text{mm}$

$1864\text{mm} / 152\text{mm} = 12.26 = \text{Qty. RR2} = 13\text{No.}$

Components required = 1No. RR1 + 13No. RR2

PEMKO Ramps

Aluminium - Modular Ramp & Threshold System

- The Pemko Aluminium Modular Ramp and Threshold system can be assembled to meet any going length with a gradient of 1:12 to the satisfaction of Approved Document 'M' for wheelchair disabled users of a building.
- This patented modular system is highly versatile with numerous interlocking components to suit Floor Offsets (Drops) of 12.7 mm - 57.2mm. Floor Offsets in excess of 57.2mm can be accommodated by use of optional riser components. The system may be finished by using feathered grout at the ramp / threshold ends. Alternatively an aesthetically pleasing finished appearance can be achieved by using system mitred trims (wings) and wing extensions.
- Ramp support components form part of the system design where additional support is required for heavy duty applications,
- The components are generally offered with a milled aluminium finish. For bespoke systems, (manufactured at the factory to suit particular location design requirements), the system components can be factory finished with a PemKote™ skid resistant surface coating. This durable finish is supported by a ten year guarantee and has been tested to Underwriters Laboratories test UL410. The finish satisfies the requirements of United States standards ASTM D 2047 and Federal Specification P-F-430C.
- An extensive range of coordinated components make up this proven and versatile system.



For full details, including AutoCAD downloads, visit the Pemko web site www.pemko.com.

- The Aluminium Modular Ramp & Threshold System with interlocking components provides for ease of installation with ramp components usually firmly fixed using mechanical fixings. (No. 10 Stainless steel screws recommended).

NOTE: This illustration shows just two of the extensive range of components that make up the Pemko Aluminium Modular Ramp & Threshold System. For further details contact Pemko UK or visit our website www.pemko.com.

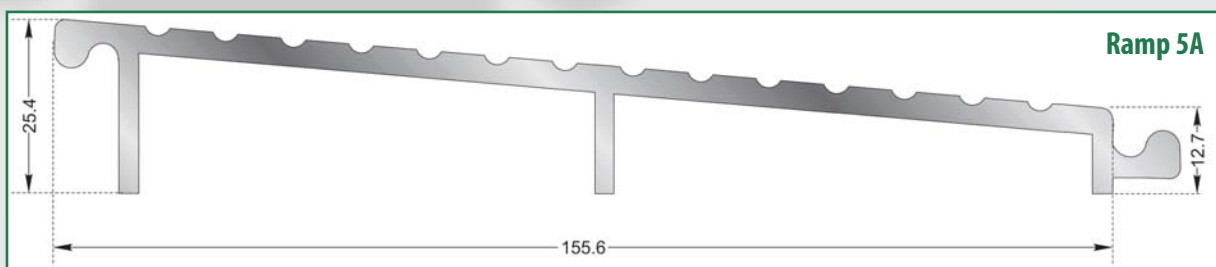
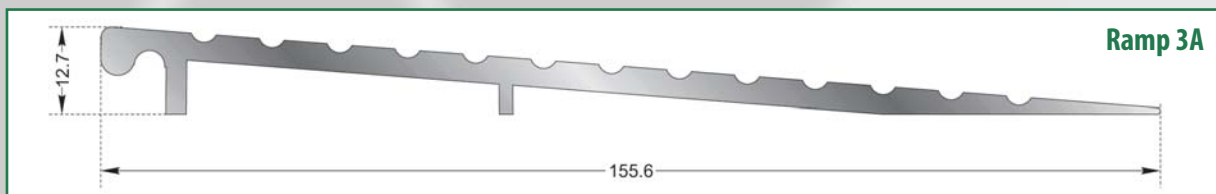

TYPICAL APPLICATION

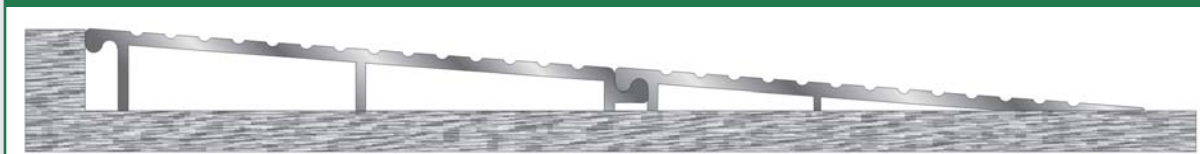

PEMKO Ramps

Recycled Rubber Ramp

- The 'environmentally friendly' Pemko RubberRamp unit is manufactured from 100% recycled rubber tyres.
- The unique Pemko exclusive 'Diamond Waffle' pattern is moulded into the ramp face providing for enhanced skid resistance when tested to Underwriters Laboratories test UL 410 (Slip Resistance Floor Materials) to the satisfaction of United States standards ASTM D2047 and Federal Specifications P-F-430C.
- The rubber ramp is available in a range of 'standard' sizes (See below) and can be trimmed without the need for special tools. The bottom of the ramp can be planed to accommodate uneven floor surfaces.
- The ramp is simple to install being fixed with an adhesive. Pemko strongly recommends the use of their Silicone adhesive for fixing the Rubber Ramp. (The recommended Silicone adhesive is available as an optional extra from Pemko - 'No Nails' or similar adhesives should not be used with the Recycled Rubber Ramp)
- The Recycled Rubber Ramp is ideal for use as an upgrade product where ramps are required to provide for wheelchair disabled access into existing shops, offices etc.



For full details, including AutoCAD downloads, visit the Pemko web site www.pemko.com

Recycled Rubber Ramps

Part No.	Width 'A'	Width 'B'
RR1.25FMR36	914.4mm	1041.4mm
RR1.25FMR48	1219.2mm	1346.2mm
RR1.25FMR60	1524mm	1651mm
RR1.25FMR62	1828.8mm	1955.8mm

NOTES:

- 1: Ramps wider than 1041.4mm (41 in.) are supplied as two piece assemblies.
- 2: Other 'bespoke' sizes are available to order. Contact Pemko UK for further details.

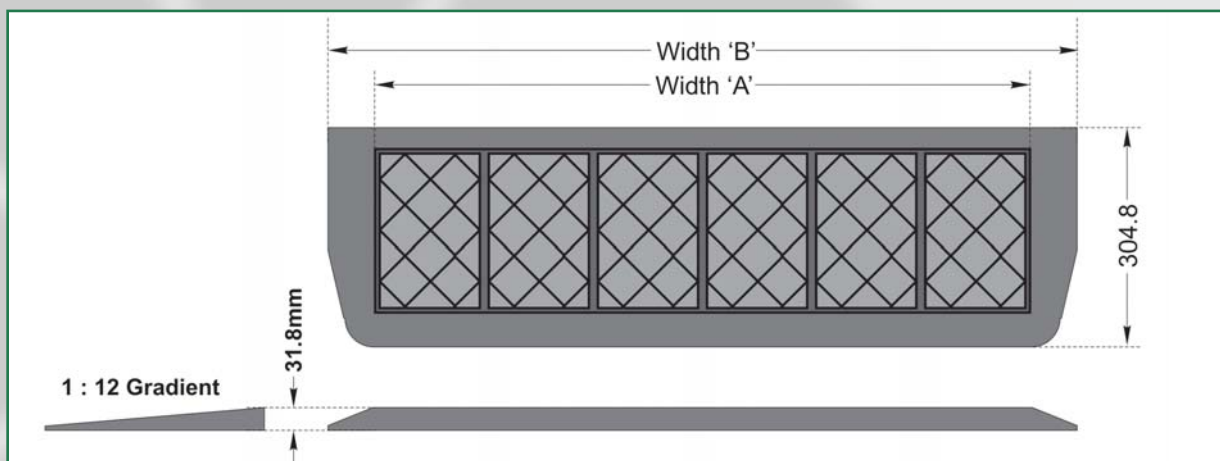

PEMKO Jamb & Head Seals

Approved Document 'M' requires that the force to operate a door leaf should not exceed 20N. It is likely that this performance requirement might not be achievable for some locations where closer forces and the influence of seals used for smoke sealing or acoustic performance requirements will add to operating forces.

The Pemko S88 and Pemko PK55 PemkoPrene™ 'Tear Drop' seals incorporate flexible design features that are effective over a wide temperature range providing for optimum sealing with minimal interference to operating forces.

S88 SiliconSeal™

- Extruded from high temperature silicone: effective between -100°F & 800°F.
- Seals begin compressing at 6.35mm and can be compressed sufficiently to seal openings of 1.6mm.

NOTE: For optimum performance compression seals should compress to approx. 50% of their uncompressed dimension (i.e. for the S88 - to approx 3mm.) Over compression of seals can reduce performance.

- Self extinguishing and non-toxic under fire conditions.
- Unaffected by sunlight, ozone and ultraviolet rays.



PK55 PemkoPrene™

- Seals begin compressing at 4.8mm and can be compressed sufficiently to seal openings of 1.6mm.

NOTE: For optimum performance compression seals should compress to approx. 50% of their uncompressed dimension (i.e. for the PK55 - to approx 2mm.) Over compression of seals can reduce performance.

- Excellent resistance to 'compression set', particularly at elevated temperatures and when compressed for extended periods of time.
- Stays flexible between -70°F and 250°F with very high resistance to 'flex fatigue'.
- Outstanding ozone resistance rating.



Seal Colours: Black / Clear / Dark Bronze / Beige / White



Visit www.pemko.com for further details.

Pemko S88 & PK55 Applications

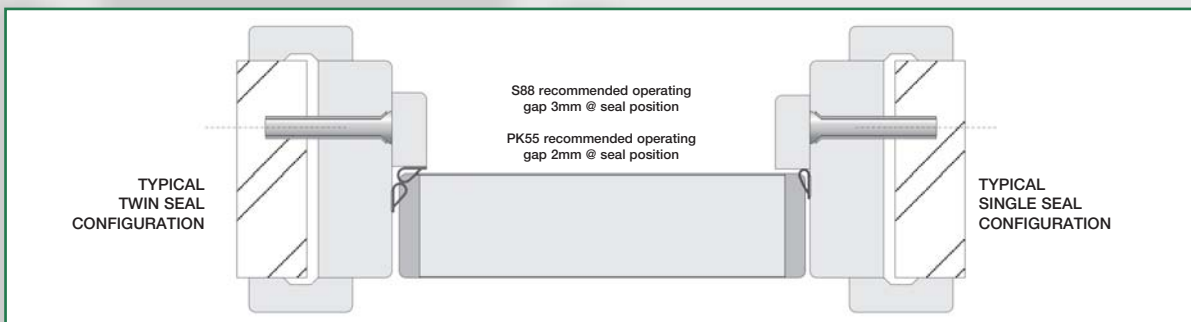

This detail illustrates the recommended locations for 'Tear Drop' seals. This location will clear most ironmongery (hardware) and fire seal fittings.

'Tear Drop' seals can be used in a single seal or twin seal configuration, in parallel or in a corner configuration (as illustrated). A twin seal arrangement is likely to apply to locations where a sound attenuating performance is required.

NOTE: It is recommended that all door edges on the closing face (frame door stop face) of the door are profiled with a 3mm radius edge to act as a lead for the compression of the seal. This will prevent 'snagging' of the seal and extend seal life.

PEMKO Threshold Drop Seals

Approved Document 'M' requires that the force to operate a door leaf should not exceed 20N. It is likely that this performance requirement might not be achievable for some locations where closer forces and the influence of seals used for smoke sealing or acoustic performance requirements will add to operating forces.

Pemko provide an extensive range of threshold drop seals that may be used for smoke sealing purposes (where the under door gap exceeds 3mm) or for sound attenuating, light tight or other performance requirements.

All Pemko Threshold drop seals incorporate Pemko's patented low friction 'Feather Touch' technology resulting in minimal operating forces.

- Optimum performance is achieved when the seal is adjusted to grip a 50-70 gsm piece of paper that can be withdrawn without tearing.
- Unless otherwise specified the seal element consists of a closed cell sponge neoprene insert to Pemko's patented 'tri-fin' design. The seal maintains pliability down to -70°F. The sealing element benefits from good 'memory' and durability characteristics.
- Other seal element options are available where specified.

 Visit www.pemko.com for further details.

TYPICAL PEMKO 411 APPLICATION

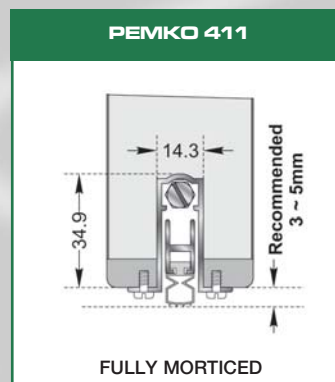
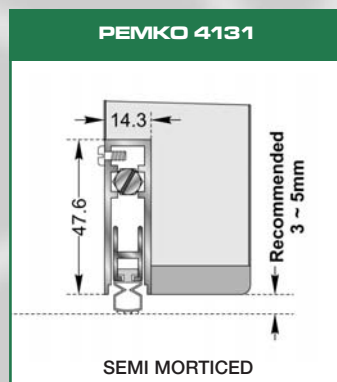
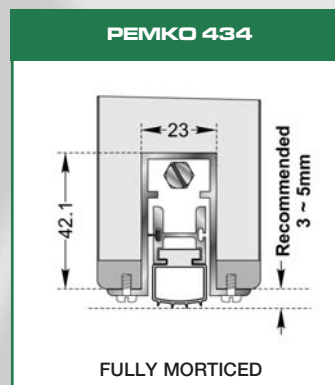
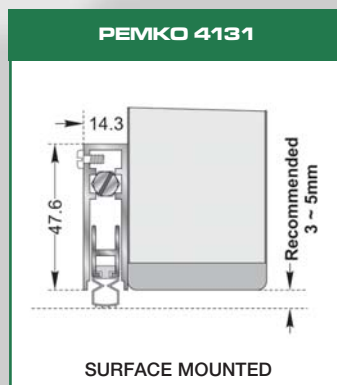
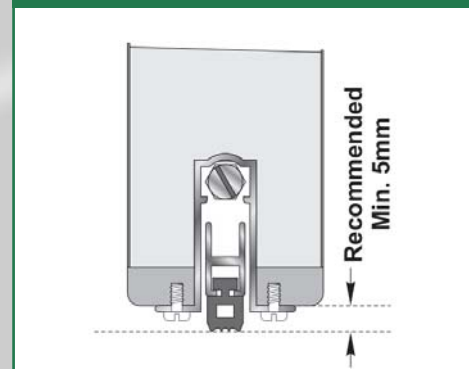

Security

GENERAL

Generally access control will require two seemingly opposing performances:

- To make access more difficult - i.e. security.
- To provide for ease of access - simplifying the flow of 'traffic', particularly for disabled persons.

SECURITY

Security requirements vary according to the location of a doorset. Generally higher levels of security are required for external doors.

Internal doors generally require a lower level of security except for 'protected areas' or for 'compartment' doors e.g. flat entrance doors.

There are an extensive number of product standards and tests to measure the robustness and security performances of a doorset. In all cases, it is the performance of the doorset as a whole, (including the quality of installation) and not the performance of individual components that will determine the level of security that can be provided by a particular doorset design.

The following British Standards are identified for further reference:

DD171 / BS EN 1192

For most applications, the performance of a doorset may be graded as Light Duty, Medium Duty, Heavy Duty or Severe Duty by reference to BS EN 1192 : 2000. This standard should be read with BS EN 12400 : 2002 with repeated opening and closing carried out in accordance with BS EN 1191 and operating forces measured in accordance with pr EN 12217.

In the United Kingdom specifiers can benefit from 'product assurance schemes' offered by test laboratories. Most UKAS approved laboratories offer a Dynamic Testing facility for doorsets. Currently testing is generally carried out in accordance with DD171 modified to accommodate the latest European Standards where these replace existing DD171 tests, specifically:

DD171 4.8 Downward deformation test - replaced by BS EN 948 Static Torsion test.

DD171 - 4.5 Heavy body impact test - replaced by BS EN 949 Soft & heavy body impact test.

DD171 4.6 Hard body impact test - replaced by BS EN 950 hard body impact test.

Security - Doorsets- Vulnerable Areas:

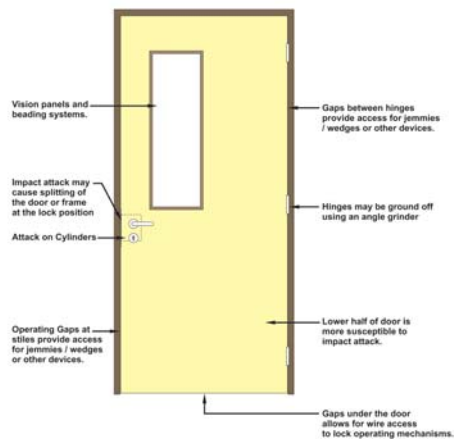

PAS23-1 & PAS24-1

Specific test standards apply to Single Leaf External Doors to Dwellings:

PAS23-1: 1999 General performance requirements for door assemblies.

PAS24-1: 1999 Enhanced security performance requirements for door assemblies.

Many Local Authorities require evidence of testing to PAS 23/24 for local authority dwellings as part of the 'Secure by Design' programme that is approved by many of the police services in the United Kingdom.

Burglar Resistance

Where higher levels of security are required, reference may be made to DD ENV 1627:1999.

This standard lists Classifications for Burglar Resistant doorsets with reference to DD 1628 : 1999 (Static Loading), DD 1629 : 1999 (Dynamic Loading) and DD ENV 1630 : 1999 (Manual Burglary attempts) that describe the test methods to be employed according to the required classification.

Explosion Resistance

Specialist doorsets may be required for Explosion Resistance, in this case reference should be made to BS EN 13122 - : 2001, BS EN 13123-2 : 2004, BS EN 13124-1 : 2004 and BS EN 13124-2 : 2004.

NOTE: The testing and performance classification for security doorset generally applies to the doorset as a whole, i.e. door / frame / glazing (if any) / hardware and installation.

PEMKO SECURITY PRODUCTS

Pemko manufacture a range of products that have been successfully tested with doorsets that have achieved high levels of security performance both in the United States and in the United Kingdom.

As with many performance doorsets, high levels of security are generally achieved where the door is mounted in a four sided frame with the threshold detail being the same as the head detail. However, for many locations, this design might not be suitable (e.g. where disabled persons or wheeled traffic is required to pass through the opening).

THRESHOLDS AND SADDLES

To satisfy these considerations Pemko offer a wide range of thresholds some of which satisfy Approved Document 'M' requirements for disabled persons and are suitable for wheelchair 'traffic'. Other 'standard' designs incorporate a 'keep' feature for use with multi locking devices that are often required for the higher levels of security performance.

PEMKOHINGE™

The Pemko Continuous Geared Aluminium hinges are suitable for door weights up to 345kgs. Use of this hinge prevents direct jimmy access to the operating gaps between the door and the frame at the hanging stiles. The continuous geared hinge may be used with security hinge bolts for added protection.

NOTE 1: The Pemko Continuous Hinge is also available with magnetic sensors that may be used to monitor door operation and with conduit for linkage to electrically operated locks.

NOTE 2: Security hinge bolts are available as an optional extra for use with the PemkoHinge™.

PEMKO ASTRAGALS

While the PemkoHinge™ provides for an effective barrier against jimmy attack at the hanging stiles, the closing stiles of a single leaf doorset and the meeting stiles of a pair of doors may be vulnerable to attack.

The Pemko Steel Astragals provide for a simple but effective barrier against such attack by restricting access to operating gaps at the closing or meeting stiles.

The simple bolt through design of the astragals provides for added security by clamping the door leaf at the lock position with improved resistance to splitting (particularly applicable to wood doors) when subjected to heavy impact attack.

PEMKO SECURITY DROP SEALS

Pemko offer Security Door Bottoms based upon the durable and successful range of drop seal designs.

The Security Drop Seals protect against 'attack' at a vulnerable position under the door leaf and may be used with a supplementary Stop Bar to further enhance security.

The security drop seal employ Pemko's 'Feather Touch' design features with low force operation yet still provides for an effective deterrent against exploitation of under door gaps. In addition, the drop seal provides for an effective barrier to rodents and other vermin.

PEMKOHINGE™

Continuous Geared Aluminium Hinges

- The use of traditional hinges will result in gaps between the hinge positions that can be exploited by burglars to gain access to a building. The full door height design of the PemkoHinge™ results in the elimination of visible operating gaps at the hanging stiles and restricts jemmy attack at this otherwise vulnerable position.
- Hinge positions can be further reinforced by the use of hinge bolts if required.
- PemkoHinge™ provides for exceptional weight bearing capabilities and are suitable for use with heavy security grade doorsets. They benefit from a proven fire rated performance up to FD60 (BS 476 Pt.22).
- PemkoHinge™ absorbs impact and stress along the full length of the door and frame.
- The PemkoHinge™ is available in a wide range of configurations and sizes to suit almost all doorset designs.



Visit www.pemko.com for further details.

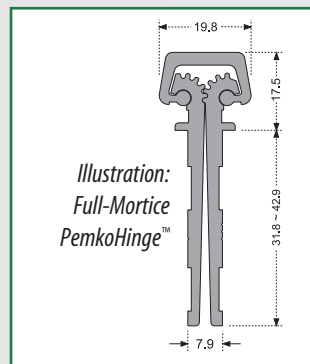

	Hinge Size (mm)	Number Bearings	Max. Door Weight (Kgs)
Standard Duty Hinges	2108	14	127
	2159	14	127
	2413	16	145
	3048	20	182
Heavy Duty Hinges	2108	27	245
	2159	27	245
	2413	31	281
	3048	39	345

Continuous Geared Aluminium Hinges



- The exceptional load bearing capabilities of the PemkoHinge™ together with a design feature that limits opportunities for forced entry attack by exploitation of operating gaps at the hanging stiles, makes the PemkoHinge™ an ideal choice for security door applications.
- Security can be further enhanced by use of hinge bolts that will prevent removal of the door leaf in the event of power tool removal of the hinge knuckle.
- For added security, the PemkoHinge™ is available (to special order) with electrical modifications to provide for Adjustable Concealed Magnetic Monitoring and Power Transfer. These features provide for linkage to Access Control systems that may be used for monitoring of door usage and for the activation and control of electrical locking systems.
- The PemkoHinge™ is available in a wide range of configurations and sizes to suit almost all doorset designs. Refer to the Pemko website (pemko.com) for further details.



PEMKO Thresholds

PEMKO 2005 Threshold

2005 Threshold Applications

- The Pemko 2005 threshold is a robust and versatile unit designed to provide for a lower bolt keep US style vertical rod and multi point panic exit devices.
- Ideal for use with Von Duprin 98/99/90027, 33/3527 and 2227 series vertical rod devices.

All Pemko thresholds are of a robust construction

- The 2005 threshold may be used to provide for a keep for the lower vertical rod of multi point securing devices.
- The low profile design of the 2005 threshold satisfies Approved Document 'M' requirements for disabled access.
- Some threshold designs incorporate Pemko's 'FG' (Frost Guard) for improved thermal insulation when used in external locations.



Visit www.pemko.com for further details.

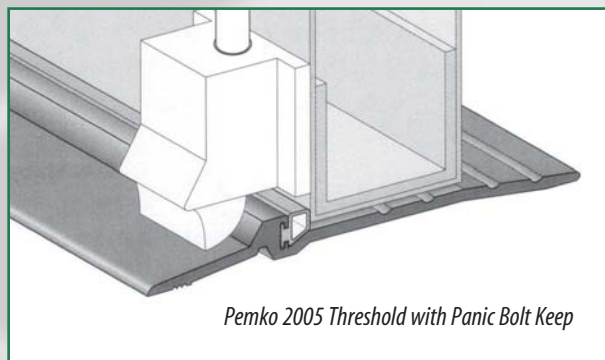

Pemko 2005 Threshold with Panic Bolt Keep

PEMKO 271 Saddle Threshold

Pemko 271 Saddle Threshold with Pemko 196 Auxiliary threshold doorstep.

- Pemko saddle thresholds are available in an extensive range of sizes and finishes.
- The 271 Saddle Threshold is one of a range of low profile saddle thresholds that meet the requirements of Approved Document 'M' specifically the needs of the wheelchair disabled.
- Saddle Threshold designs incorporating Pemko's 'FG' (Frost Guard) technology for improved thermal insulation are also available without compromising the 'disabled friendly' features illustrated for the 271 saddle.
- For improved security, the Pemko 196 Stop Bar may be fixed to the top of most saddle designs with the stop firmly anchored into the floor. This provides for a secure doorstep that restricts access under the door leaf and improves resistance to impact attack.

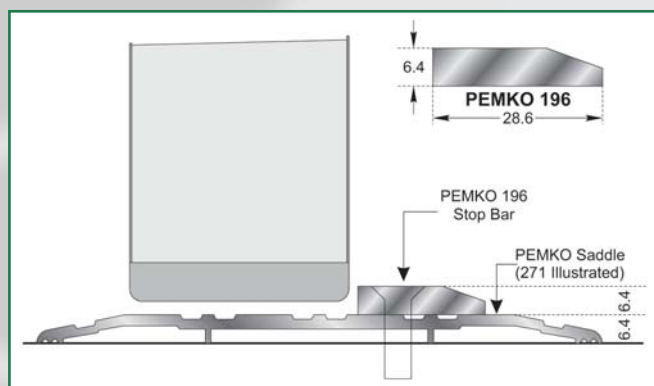

PEMKO Security Drop Seals

PEMKO Security Automatic Drop Seals

- In addition to automatic door bottoms used for weather sealing, smoke sealing and acoustic performance applications, Pemko also offers Security Door Bottoms.
- The Security Door Bottoms incorporate Pemko's low closing force 'Feather Touch' technology.
- The Security Door Bottoms restrict under door access and provide for an effective deterrent against some forms of burglar attack and the passing of possibly dangerous substances under the door leaf. These drop seals also effective as a barrier to resist rodent and vermin attack.



All Pemko drop seals incorporate Pemko's patented operating mechanism.

The design ensures that the seal will always actuate on the hinge side first. This operation results in a minimal force requirement for operation of the door leaf and enhanced durability due to reduced friction during operation. The progressive action of the sealing element ensures that optimum sealing is achieved.

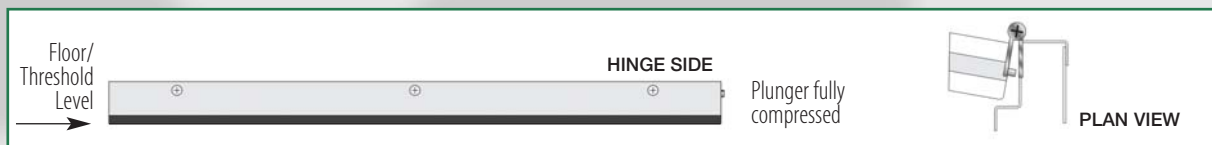
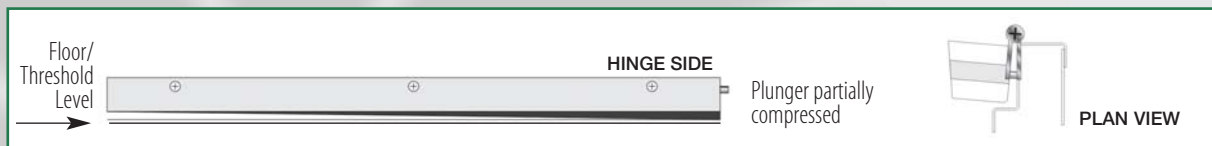
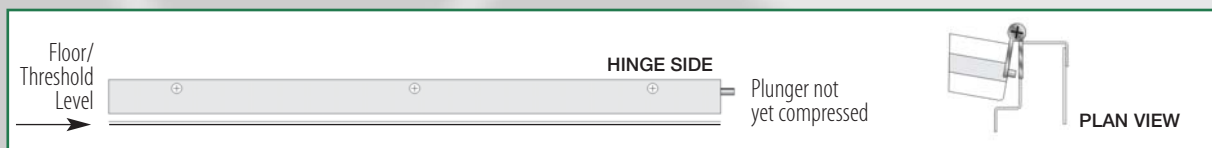

PEMKO Security Drop Seals

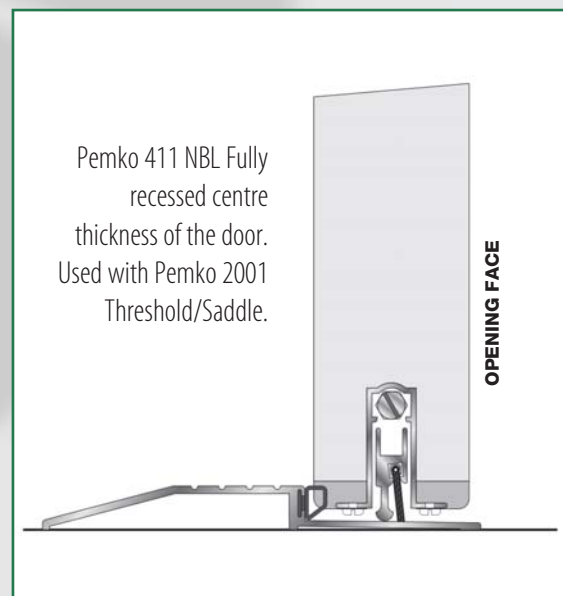
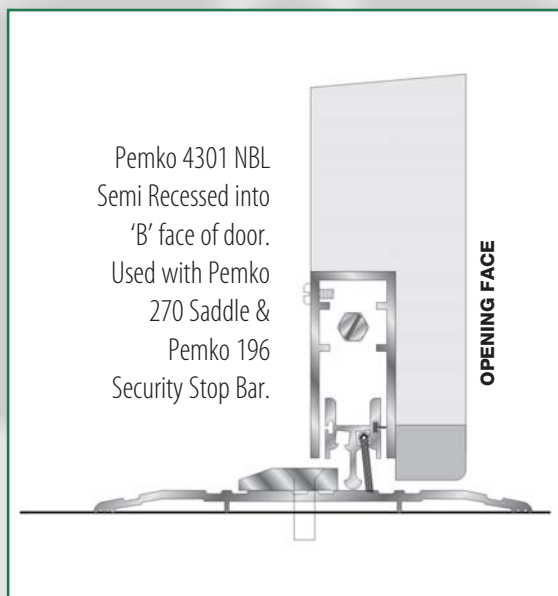
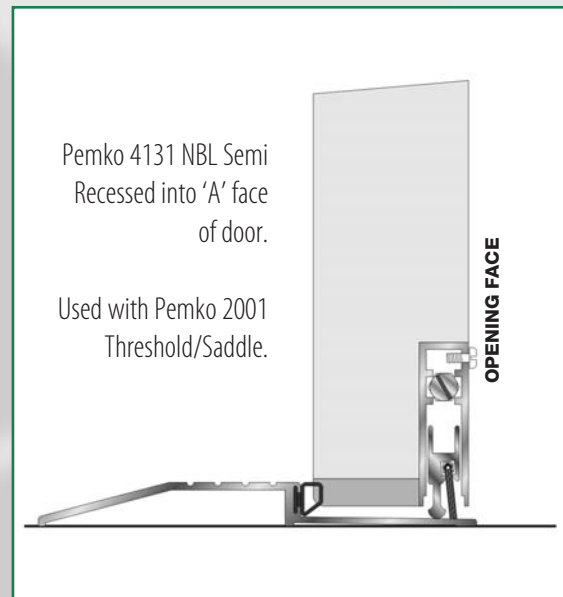
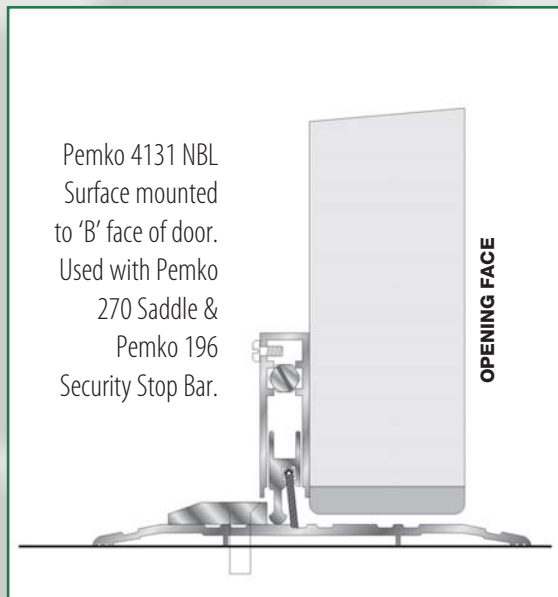

NOTE: These details illustrate some of the possible applications for the use of Pemko security drop seals. These are intended for use with external opening out doors.



Visit www.pemko.com for further details.

Security Astragal Closing Stile

PEMKO 3572 SPND

The Pemko 3572 Security Astragal is available in a galvanised steel finish suitable for priming and painting.

- The astragal is supplied complete with grommet (Thru-bolt) fixings providing for an effective deterrent against drilling.
- The Pemko 3572 Security Astragal is designed to protect against forced entry attack by restricting access to the operating gap at the closing stile.

NOTE: It is recommended that Pemko Continuous hinges are used with astragals to provide for a similar security function at the hanging stiles.

- The Closing Stile Astragal Guard can be used with Steel or Wood doors.

NOTE: When used with wood doors it is recommended that a 20x3mm fixing plate is fitted to the 'B' face of the door to prevent fixings biting into the door structure.

- Astragals to be drilled to suit ironmongery fittings.

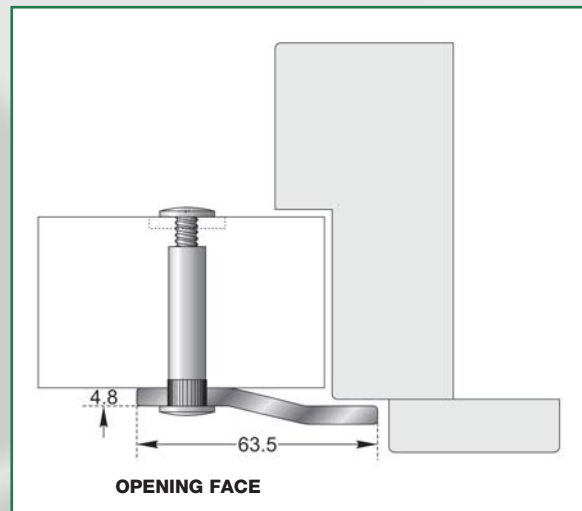

Security Astragal Meeting Stiles

PEMKO 357 SPND

The Pemko 357 Security Astragal is available in a galvanised steel finish suitable for priming and painting.

The astragal is supplied complete with grommet (Thru-bolt) fixings providing for an effective deterrent against drilling.

The Pemko 357 Security Astragal is designed to protect against forced entry attack by restricting access to the operating gap at the meeting stiles of pairs of doors.

NOTE: It is recommended that Pemko Continuous hinges are used with astragals to provide for similar security function at the hanging stiles.

The Closing Stile Astragal Guard can be used with Steel or Wood doors.

NOTE: When used with wood doors it is recommended that a 20x3mm fixing plate is fitted to the 'B' face of the door to prevent fixings biting into the door structure.

Astragals to be drilled to suit ironmongery fittings.

Also available in Stainless Steel.

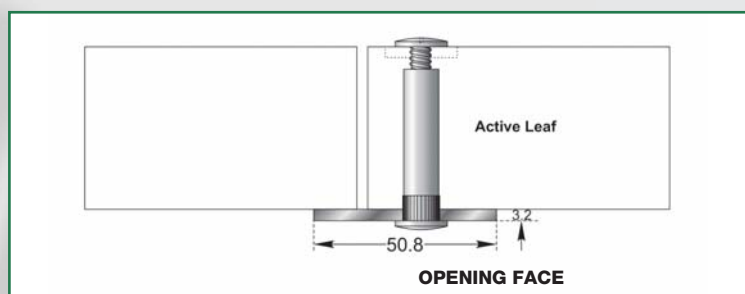



ASSA ABLOY

UK Office

Pemko Manufacturing Company

P.O. Box No. 515

Bury St. Edmunds IP29 4WP

Tel/Fax: 01284 735005

E-mail: pemkouksales@pemko.com

PEMKO CANADA
Abbotsford, B.C.
(Headquarters & Main Plant)

Belleville, Ontario
(Distribution Center)

PEMKO U.S.
Ventura, California
(Corporate Offices
& Main Plant),

Memphis, Tennessee
(Plant)

FIND OUT MORE INFORMATION ON

www.pemko.co.uk

Distributor:



*Specifically designed and
manufactured for the United Kingdom*



© 2005 Pemko Manufacturing Company
Prepared for Pemko UK by Tony Palmer (Doortech 2000)
Tel: 01271 345038 • Fax: 01271 345038
E-mail: tony@doortech.fsnet.co.uk